

ESSENZA  
MINI  
MY MACHINE

**NESPRESSO**<sup>®</sup>

ⓔⓃ	Instruction manual	ⓄⓃ	用户手册	3
ⓓⓀ	使用指南	ⓀⓂ	사용 설명서	18
ⓉⓌ	使用手冊			33

Nespresso is an exclusive system creating the ultimate Espresso, time after time. All Nespresso machines are equipped with a unique extraction system that guarantees up to 19 bar pressure. Each parameter has been calculated with great precision to ensure that all the aromas from each capsule can be extracted, to give the coffee body and create an exceptionally thick and smooth crema.

奈斯派索独有的咖啡萃取系统一如既往的制造出极致的浓缩咖啡。所有的奈斯派索咖啡机均配备此独有的系统以保证提供19巴的萃取压力。系统的每一个参数均通过精确的计算，以确保各种咖啡胶囊所有的香味均被萃取出来，并带给您细腻并具有浓厚质感的咖啡油沫。

**⚠ CAUTION:** when you see this sign, please refer to the safety precautions to avoid possible harm and damage.

**i INFORMATION:** when you see this sign, please take note of the advice for the correct and safe usage of your coffee machine.

**⚠ 警告-:** 当看到此标志请参考安全预防措施手册以避免可能的伤害和损坏。

**i 信息-** 当看到此标志,请参考正确和安全使用咖啡机的建议。

## Content / 内容

Packaging Content / 包装细目	3
Safety Precautions / 安全须知	4-8
Machine Overview / 设备概览	9
Specifications / 规格清单	9
First Use Or after a long period of non-use / 首次使用 (或长期闲置后)	10
Coffee Preparation / 咖啡制备	10-11
Programming the Water Volume / 预设杯量	11
Energy saving mode / 节能模式	12
Reset to Factory Settings / 恢复出厂设置	12
Cleaning / 清洁	13
Descaling / 除垢	13-15
Emptying the System before a period of non-use and for frost protection, or before a repair / 将长时间不使用,防结霜或维修前需清空机器	15
Troubleshooting / 故障排除	16
Disposal and Environmental Protection / 废弃处理及环境保护	16
Limited Guarantee / 有限保修	17
Contact Nespresso Club / 联系奈斯派索会员俱乐部	17

## Packaging Content / 包装细目

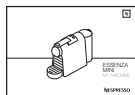

User manual  
用户手册



«Welcome to Nespresso» Folder  
“欢迎加入奈斯派索”文件夹



Nespresso capsule tasting gift  
奈斯派索咖啡品尝礼盒

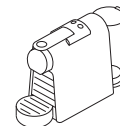

Coffee Machine  
咖啡机



**⚠ CAUTION:** when you see this sign, please refer to the safety precautions to avoid possible harm and damage.

**i INFORMATION:** when you see this sign, please take note of the advice for the correct and safe usage of your appliance.

**⚠ CAUTION:** the safety precautions are part of the appliance. Read them carefully before using your new appliance for the first time. Keep them in a place where you can find and refer to them later on.

- The appliance is intended to prepare beverages according to these instructions.
- Do not use the appliance for anything other than its intended use.
- This appliance has been

designed for indoor and non-extreme temperature conditions use only.

- Protect the appliance from direct sunlight effect, prolonged water splash and humidity.
- This appliance is intended to be used in households and similar applications only such as: staff kitchen areas in shops, offices and other working environments, farm houses; by clients in hotels, motels and other residential environments; bed and breakfast type environments.
- This appliance may be used by children of at least 8 years of age, as long as they are supervised and have been given instructions about using the appliance safely and are fully aware of the dangers involved. Cleaning and user maintenance shall not be made by children unless they are older than 8 and

they are supervised by an adult.

- Keep the appliance and its cord out of reach of children under 8 years of age.
- This appliance may be used by persons with reduced physical, sensory or mental capabilities, or whose experience or knowledge is not sufficient, provided they are supervised or have received instruction to use the appliance safely and understand the dangers.
- Children shall not use the appliance as a toy.
- The manufacturer accepts no responsibility and the guarantee will not apply for any commercial use, inappropriate handling or use of the appliance, any damage resulting from use for other purposes, faulty operation, non-professionals' repair or failure to comply with the instructions.

### **Avoid risk of fatal electric shock and fire**

- In case of an emergency: immediately remove the plug from the power socket.
- Only plug the appliance into suitable, easily accessible, earthed mains connections. Make sure that the voltage of the power source is the same as that specified on the rating plate. The use of an incorrect connection voids the guarantee.

### **The appliance must only be connected after installation**

- Do not pull the cord over sharp edges, clamp it or allow it to hang down.
- Keep the cord away from heat and damp.
- If the supply cord or the plug are damaged, they must be replaced by the manufacturer, its service agent or similarly qualified persons, in order to avoid all risks.

- If the supply cord or the plug are damaged, do not operate the appliance. Return the appliance to the *Nespresso* Club or to a *Nespresso* authorized representative.
  - If an extension cord is required, use only an earthed cord with a conductor cross-section of at least 1.5 mm<sup>2</sup> or matching input power.
  - To avoid hazardous damage, never place the appliance on or beside hot surfaces such as radiators, stoves, ovens, gas burners, open flame, or similar.
  - Always place it on a horizontal, stable and even surface. The surface must be resistant to heat and fluids, like water, coffee, descaler or similar.
  - Disconnect the appliance from the mains when not in use for a long period. Disconnect by pulling out the plug and not by pulling the cord itself or the cord may become damaged.
  - Before cleaning and servicing, remove the plug from the mains socket and let the appliance cool down.
  - To disconnect the appliance, stop any preparation, then remove the plug from the power socket.
  - Never touch the cord with wet hands.
  - Never immerse the appliance or part of it in water or other liquid.
  - Never put the appliance or part of it in a dishwasher.
  - Electricity and water together is dangerous and can lead to fatal electrical shocks.
  - Do not open the appliance. Hazardous voltage inside!
  - Do not put anything into any openings. Doing so may cause fire or electrical shock!
  - The use of accessory attachments not recommended by the manufacturer may result in fire, electric shock or injury to persons.
- Avoid possible harm when operating the appliance**
- Never leave the appliance unattended during operation.
  - Do not use the appliance if it is damaged, has been dropped or not operating perfectly. Immediately remove the plug from the power socket. Contact the *Nespresso* Club or *Nespresso* authorized representative for examination, repair or adjustment.
  - A damaged appliance can cause electrical shocks, burns and fire.
  - Always completely close the lever and never lift it during operation. Scalding may occur.
  - Do not put fingers under coffee outlet, risk of scalding.
  - Do not put fingers into capsule compartment or the capsule shaft. Danger of injury!
  - Water could flow around a capsule when not perforated by the blades and damage the appliance.
  - Never use an already used, damaged or deformed capsule.
  - If a capsule is blocked in the capsule compartment, turn the machine off and unplug it before any operation. Call the *Nespresso* Club or *Nespresso* authorized representative.
  - Always fill the water tank with cold, fresh drinking water.
  - Empty water tank if the appliance will not be used for an extended time (holidays, etc.).
  - Replace water in water tank when the appliance is not operated for a weekend or a similar period of time.
  - Do not use the appliance without the drip tray and drip grid to avoid spilling

any liquid on surrounding surfaces.

- Do not use any strong cleaning agent or solvent cleaner. Use a damp cloth and mild cleaning agent to clean the surface of the appliance.
- To clean machine, use only clean cleaning tools.
- When unpacking the machine, remove the plastic film and dispose.
- This appliance is designed for *Nespresso* coffee capsules available exclusively through the *Nespresso* Club or your *Nespresso* authorized representative.
- All *Nespresso* appliances pass stringent controls. Reliability tests under practical conditions are performed randomly on selected units. This can show traces of any previous use.
- *Nespresso* reserves the right to change instructions without prior notice.

### Descaling

- *Nespresso* descaling agent, when used correctly, helps ensure the proper functioning of your machine over its lifetime and that your coffee experience is as perfect as the first day.
- Descale according to user manual recommendations.

### SAVE THESE INSTRUCTIONS

**Pass them on to any subsequent user. This instruction manual is also available as a PDF at [nespresso.com](http://nespresso.com)**

## 安全须知



**⚠ 注意：此标志提示您参阅安全须知，以避免可能的伤害和破损。**

**ℹ 信息：此标志提示您采用正确和安全的方法使用咖啡机。**

**⚠ 注意：本安全须知是设备的一部分。请在第一次使用新设备前仔细阅读。请将本说明书妥善保存，以便后续使用。**

- 请根据如下指示使用该设备制备饮料。
- 请勿将咖啡机用于其它用途。
- 本产品只适用于室内使用。请勿在极端温度下使用。
- 请勿将机器放在阳光直射的地方、水花四溅的地方及潮湿的地方。
- 本咖啡机是为了家庭使用而设计。不适用于商

店里的员工餐厅，办公室和其他办公场所，乡村酒店，各类酒店房间内，汽车旅馆和其它提供住宿的场所，或其他简易旅馆类的环境供客人使用。

- 此设备不得由8岁以下的儿童使用，除非有人监督，同时他们已经获得了如何安全使用本产品的相关指导，并且理解相关危险。8岁以下儿童不得在没有监护的情况下对机器进行清洗和维护。
- 请将咖啡机及其电源线放到8岁以下儿童接触不到的地方。
- 此设备不适合由肢体、感官或精神能力低下或缺乏经验和知识的人使用，除非有人监督或他们已经获得了如何安全使用本产品的相关指导，并且理解相关危险。
- 儿童不得玩耍该产品。

- 生产商对将产品用于任何商业用途、不当的使用、或因用作其它用途导致的损坏、错误的操作、由非专业人士进行维修或不遵守使用说明书操作而导致的产品的损坏，既不负任何责任亦不提供保修。

### 避免致命触电和火灾的危险。

- 紧急情况下请立即拔下电源插头。
- 应将本设备连接到正确的，方便连接的且有接地保护的电源插座上。使用电压必须与铭牌上要求的电源电压一致。连接到错误电源导致的损坏不在本保修范围之内。

### 设备必须在装配好后方可连接电源。

- 不要在锋利的物体边缘拉动电线，或将其绑起或挂起。

- 电源线应始终远离热源和潮湿环境。
- 如果电线或插头损坏，需送回厂家、服务商或者具有类似认可资质人员进行更换，以免造成危险。
- 如果电线或插头损坏，请停止使用。请将设备送回奈斯派索用户俱乐部或授权方进行检查，维修或调整。
- 如果需要延长电源线，只能选用有接地保护的且导体截面至少为1.5平方毫米的导线，或与输入功率相匹配的电线。
- 为避免严重损坏，切勿把机器放置于发热物体表面上或附近，如散热器、火炉，烤箱，燃气炉，明火炉或类似器具。
- 始终放置在水平，稳定和平整的平面。该平面必须抗热防水、咖啡、除垢剂或类似物质。
- 长时间不使用请拔下电

- 源插头。断开电源连接时，请拔插头，不要拉电线，避免损坏电线。
- 清洁和维修前，先将插头从插座上拔出，并冷却咖啡机。
- 断开奶泡机电源前，请先让机器停止工作，然后拔出插头
- 切勿用潮湿的手触摸电源线。
- 切勿将设备全部或部分放在水中或其他液体中。
- 请勿将咖啡机或其任何部分放入洗碗机内。
- 电和水接触非常危险可能导致致命的触电。
- 请勿自行拆解咖啡机。内部有电，危险！
- 切勿往机器的缝隙内放置任何物品。这样做可能会引起火灾或电击。
- 使用非原厂推荐的配件可造成火灾，电击或使人受伤。

### 操作机器过程中避免可能的伤害。

- 切勿让咖啡机于无人看守时运作。
- 设备损坏或不能正常工作时请停止使用。立即将电源插头从插座中拔出。联系Nespresso俱乐部或授权方进行测试，维修或调整。
- 损坏的设备可能导致触电，灼伤或火灾。
- 在操作过程中始终关闭滑盖。避免烫伤。
- 请勿将手指放在咖啡出水口下方以免烫伤。
- 切勿将手指放在粉囊仓或粉囊轴内避免受伤。
- 粉囊如果没有被刀片刺破，水会从粉囊周围溢出可能损坏机器。
- 请勿使用已用、损坏或变形的胶囊。
- 如果粉囊被堵塞在机器内部，请关掉机器电源并拔下电源插头。拨打Nespresso会员俱乐部或授权方进行咨询。



## Ⓢ 安全须知

- 仅可以向水箱内注入冷的，新鲜的饮用水。
- 如果将很长时间不使用咖啡机请清空水箱。（假期等）。
- 如果一个周末或相同长度的时间未使用机器，请换掉水箱中剩余的水。
- 不要使用没有滴水盘和金属托盘的设备，以避免液体飞溅和蔓延到机器周围。
- 切勿使用强烈的清洁剂或溶剂。使用湿布及温和清洁剂清洁咖啡机表面。
- 只可使用干净的清洁工具清洁咖啡机。
- 打开机器包装时，移除并丢弃塑料薄膜。
- 本Nespresso咖啡机与Nespresso咖啡粉囊为配套设计，Nespresso咖啡粉囊仅可以从Nespresso会员俱乐部或授权方购买。
- 所有Nespresso咖啡机均通过了严格的品质控制。我们曾按照随机抽样的形式对一些机器在实际条件下进行了可靠性测试。所以有些机器会有被使用过的痕迹。
- Nespresso有权在未事先通知的情况下修改本使用手册。

### 除垢

- 正确的使用Nespresso除垢剂，有助于确保您的咖啡机功能一直如新机一般，从而让您的体验完美如初。
- 请参考用户手册推荐进行除垢操作。

**请保存此手册  
并把此手册提供给后续  
使用者。  
请访问  
nespresso.com 网站  
获得本说明书的PDF版本。**



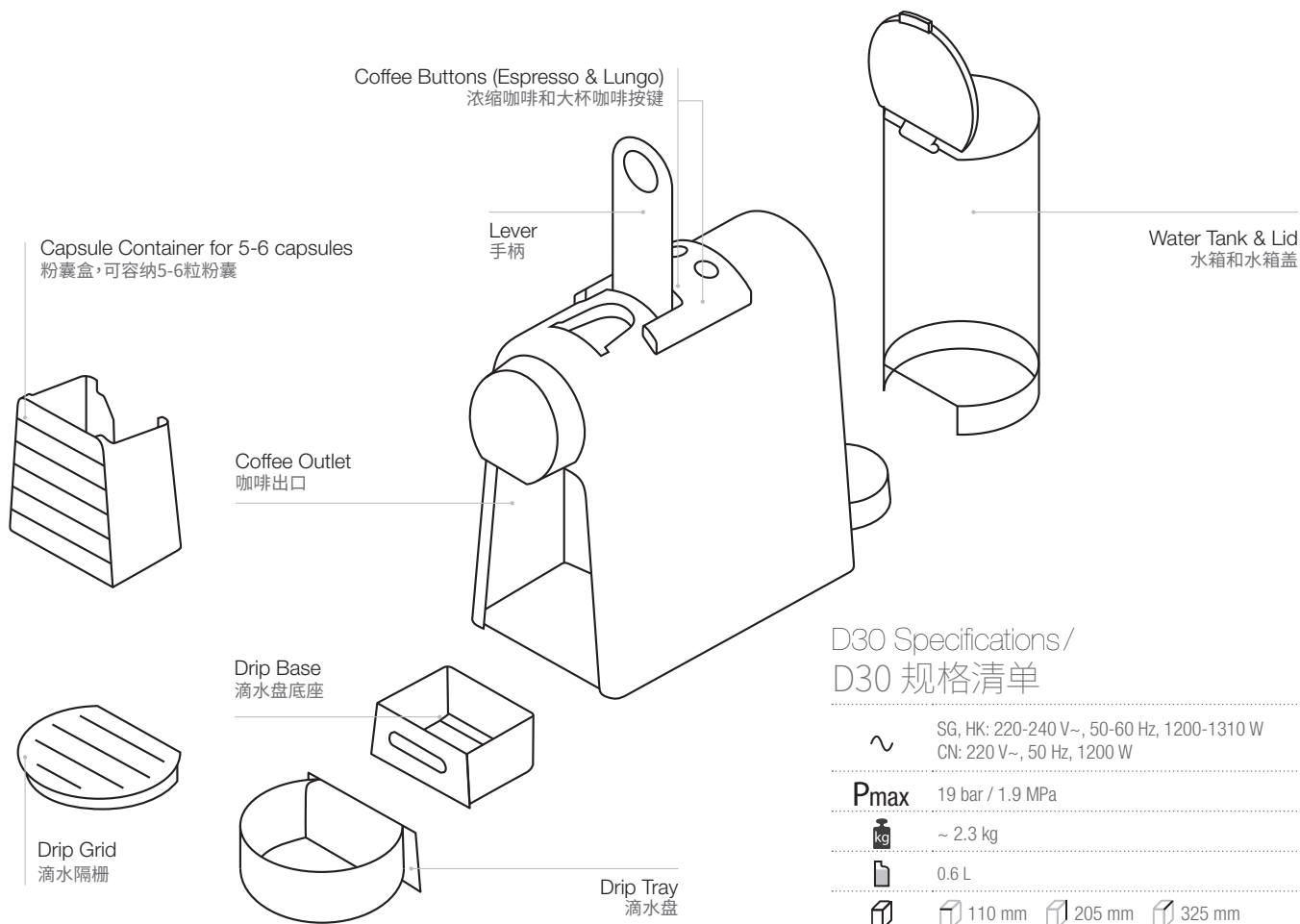

### D30 Specifications / D30 规格清单

~ SG, HK: 220-240 V~, 50-60 Hz, 1200-1310 W  
CN: 220 V~, 50 Hz, 1200 W

**Pmax** 19 bar / 1.9 MPa

**kg** ~ 2.3 kg

**l** 0.6 L

**mm** 110 mm 205 mm 325 mm

EN First use or after a long period of non-use/

CN 首次使用 (或长期闲置后)

**⚠ First, read the safety precautions** to avoid risks of fatal electrical shocks and fire.

**⚠ 注意:** 请先仔细阅读安全预防指引以防止因使用不当导致的触电和火灾的危险。

**i** **Factory settings:** Espresso cup: 40 ml, Lungo cup: 110 ml; Auto Off mode: 9 mins.  
工厂设置: 浓缩咖啡: 40毫升, 大杯咖啡: 110毫升, 自动关机: 9分钟。



**1** **Rinse the water tank** before filling with potable water.  
Place a container (min. 1 L) under coffee outlet.  
Plug into power outlet.

注入饮用水前, 冲洗水箱。  
在咖啡出口下方放置一个容器 (容积至少为1升)  
将咖啡机连上电源。



**2** **To turn the machine ON**, press either the Espresso or Lungo button.  
- Blinking Lights: heating up (25 seconds)  
- Steady Lights: ready

按下浓缩咖啡或大杯咖啡按键, 启动咖啡机。  
- 按键同时闪烁: 预热中 (25秒)  
- 闪烁停止: 可以使用

**3** **Press the Lungo button** to rinse the machine. Repeat 3 times.

按下大杯咖啡按键以冲洗机器。  
重复3次本操作。

**4** **To turn the machine off** before automatic Auto Off mode, press both the Espresso and Lungo buttons simultaneously.

手动关机: 同时按下浓缩咖啡和大杯咖啡按键。

## Coffee Preparation / 咖啡制备

**1** **To turn the machine ON**, press either the Espresso or Lungo button.  
- Blinking Lights: heating up (25 seconds)  
- Steady Lights: ready

按下浓缩咖啡或大杯咖啡按键, 启动咖啡机。  
- 按键同时闪烁: 预热中 (25秒)  
- 闪烁停止: 可以使用

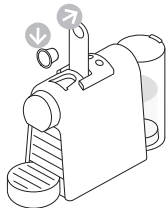

**2** **Lift the lever** completely and insert the capsule.

完全抬起操作手柄, 放入一个咖啡粉囊

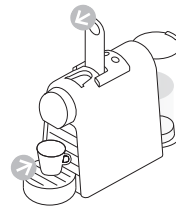

**3** **Close the lever** and place a cup under the coffee outlet.

关闭操作手柄, 并在咖啡出口处放置一个咖啡杯。

- ⚠ Never lift the lever** during operation and refer to the important safeguards to avoid possible harm when operating the appliance.
- ⚠ 注意:** 操作中,切勿提起操作手柄。请参阅安全操作指引,以免在操作咖啡机时受伤。

**i** During heat up, you can press either coffee button while blinking. The coffee will then flow automatically when the machine is ready.  
**提示:** 您也可以在加热过程中按下咖啡按钮,咖啡机将于加热完成后自动萃取咖啡。



- 4 Press the Espresso (40 ml) or the Lungo (110 ml) button to start.** Preparation will stop automatically. To stop the coffee flow or top up your coffee, press again.

**按下浓缩咖啡(40ml)或大杯咖啡(110ml)按键来开始萃取咖啡。**咖啡在到达指定杯量后会自动停止。要停止咖啡流出或添加咖啡,可再按一次咖啡按键。

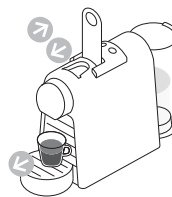

- 5 Remove the cup.** Lift and close the lever to eject the capsule into the used capsule container.

**移开咖啡杯。**提起并关闭操作手柄,咖啡胶囊将被退出并落入粉囊盒中。

## Programming the Water Volume / 预设杯量



- 1 Turn the machine on** and wait for it to be in ready mode (steady lights). Fill the water tank with fresh potable water and insert the capsule.

**启动咖啡机,**并等待咖啡机进入待用状态(按键停止闪烁)。  
在水箱中注入饮用水,并放入一颗咖啡粉囊。

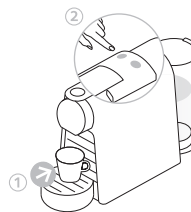

- 2 Place a cup** under the coffee outlet. Press and hold the Espresso or Lungo button. Release button once the desired volume is served. LED will blink fast 3 times to confirm new setting. Water volume level is now stored.

**在咖啡出口处放置**一个咖啡杯。  
持续按下浓缩咖啡或大杯咖啡按键。待到获得理想的杯量,即可松开按键。LED灯将会快速闪烁3次。  
杯量位置已经被设定。

## EN Energy saving mode/ 节能模式

CN

 This machine is equipped with an energy saving feature.  
机器带有节能功能。

 The machine will automatically enter Auto Off mode after 9 minutes.  
停止操作9分钟后机器自动关机。

To change this setting: 更改设置:

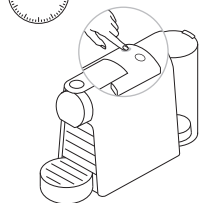

- 1 With machine turned off, press and hold the Espresso button for 5 seconds.  
The Espresso button will blink to indicate the current setting.

机器在关机的状态下,按下大杯咖啡按键并保持5秒钟。  
特浓咖啡按键将闪烁示意当前设定。

- 2 To change this setting press the Espresso button:  
One time for Auto Off mode after 30 minutes.  
One more time for Auto Off mode after 9 minutes.

- 1x Single blinking: 9 mins mode
- 2x Double blinking: 30 mins mode

### 按下大杯咖啡按键更改设置

按一次设置30分钟自动关机。  
再次按下设置9分钟自动关机。

- 1x 灯闪烁一次: 提示9分钟自动关机
- 2x 灯闪烁两次: 提示30分钟自动关机

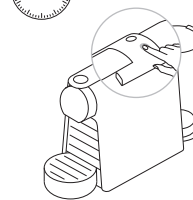

- 3 To exit the energy saving mode press the Lungo button for 5 seconds.

按下大杯咖啡按键并保持5秒钟退出设置模式。

## Reset to Factory Settings/ 恢复出厂设置

- 1 Factory settings: Espresso cup: 40 ml, Lungo cup: 110 ml; Auto Off mode: 9 minutes.  
出厂设置: 浓缩咖啡: 40 ml, 大杯咖啡: 110 ml, 省电模式: 9分钟。

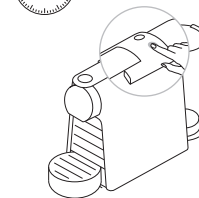
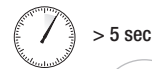

- 1 With machine turned off, press and hold down the Lungo button for 5 seconds.

机器在关机的状态下,按下大杯咖啡按键并保持5秒钟。

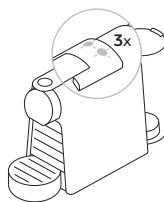

- 2 LEDs will blink fast 3 times to confirm machine has been reset to factory settings.

LED指示灯将会快速闪烁3次,确认咖啡机已经恢复出厂设置。

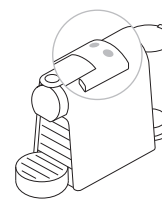

- 3 LEDs will then continue to blink normally, as heating up, until ready.  
- Steady Lights: ready

LED指示灯会继续正常闪烁表示正在加热,直到加热完成。  
- 指示灯停止闪烁: 咖啡机可供使用

- ⚠️ **Risk of fatal electrical shock and fire.** Never immerse the appliance or part of it in water. / Be sure to unplug the machine before cleaning. / Do not use any strong cleaning agent or solvent cleaner. / Do not use sharp objects, brushes or sharp abrasives. / Do not place in a dishwasher.
- ⚠️ **有触电和火灾的危险。**不要把设备全部或部分放在水中或其他液体中。清洁前须确保咖啡机已经断电。不要使用强度大的清洗剂和溶剂清洗机器。不应使用锋利的物品、刷子或尖锐的工具清洁机器。不可用洗碗机清洗。

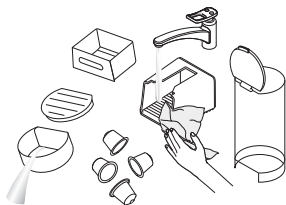

1 Empty the drip tray, the drip base and the capsule container every day. Also remove the water tank with its lid and clean them all with odorless detergent and rinse with warm / hot water.

每天清空滴水盘，滴水盘底座，粉囊盒。同时把水箱和盖子卸下来，用无香洗涤剂清洗，再用温水/热水冲洗。

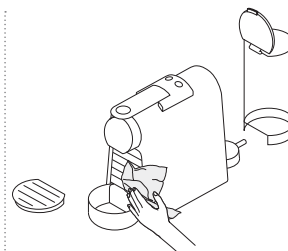

2 Dry with a fresh and clean towel, cloth or paper and reassemble all parts. Clean the coffee outlet and inside the machine regularly with a damp cloth.

用干净的毛巾、布或者纸巾擦干，装回到机器上。定期用湿布清洁咖啡出口和机器内部。

## Descaling / 除垢

- ⚠️ **The descaling solution can be harmful.** Avoid contact with eyes, skin and surfaces. The following table will indicate the descaling frequency required for the optimum performance of your machine, based on water hardness. For any additional questions you may have regarding descaling, please contact your *Nespresso Club*.
- ⚠️ **该除垢剂溶液可能造成伤害。**请避免接触眼睛和皮肤表面。下表注明了最佳除垢频率和水的硬度的关系，可根据本建议对机器进行除垢。对于任何关于除垢的问题，请联系奈斯派索用户俱乐部。

EN Descaling / 除垢

CN [www.nespresso.com/descaling](http://www.nespresso.com/descaling) / [www.nespresso.com/descaling](http://www.nespresso.com/descaling)

**i** Duration approximately 15 minutes.  
除垢过程大约需要15分钟。

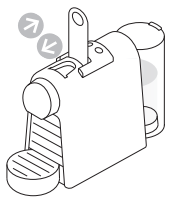

- 1** Lift and close the lever to eject the capsule into the used capsule container.

抬起手柄推出咖啡粉囊，然后关闭手柄。

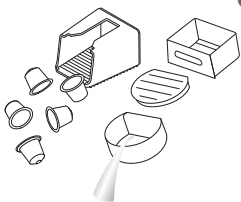

- 2** Empty the drip tray, drip base and used capsule container.

将滴水盘、滴水盘底座、粉囊盒清空。



- 3** Pour 1 Nespresso descaling liquid sachet into the water tank. Fill the water tank up to the 0.6 L line with potable water.

往水箱中加入一份奈斯派索除垢剂，再往水箱中注入0.6升饮用水。

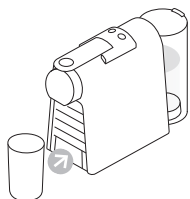

- 4** Place a container (min. volume 1 L) under the coffee outlet.

在咖啡出口下方放置一个容器（容积至少为1升）。

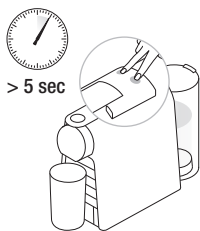

- 5** To enter the descaling mode, while the machine is turned on, press both the Espresso and Lungo buttons for 5 seconds.

在开机状态下，同时按下浓缩咖啡和大杯咖啡按键5秒钟，即可进入除垢模式。

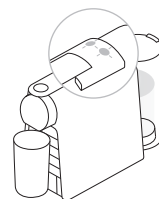

- 6** Both LEDs blink.  
两个LED指示灯均闪烁。



- 7** Press the Lungo button and wait until the water tank is empty.

按下大杯咖啡按键，直到水箱被清空。

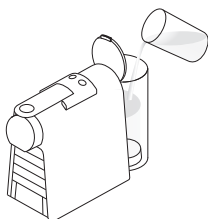

- 8** Refill the water tank with the used descaling solution collected in the container and repeat steps 4 and 7.

将容器中收集的用过的除垢液注入水箱中，重复步骤4和步骤7。



- 9** Empty and rinse the water tank. Fill with fresh potable water.

清空并冲洗水箱，将饮用水注入水箱中。

- ⑩ **When ready**, repeat steps 4 and 7 to now rinse the machine. Repeat twice.

**重复步骤4和步骤7**冲洗机器，重复两次。

- ⑪ **To exit the descaling mode**, press both the Espresso and Lungo buttons for 5 seconds.

**退出除垢模式时**，同时按下浓缩咖啡和大杯咖啡按钮5秒钟。



- ⑫ **Empty the drip base.**  
清空滴水盘底座。

#### Water hardness: / 水的硬度

	fH	dH	CaCO <sub>3</sub>	Descaling after / 除垢时间	
				 (40 ml)	
H (HIGH) / 高	36	20	360 mg/l	300	fH French degree / 法国度
M (MEDIUM) / 中	18	10	180 mg/l	600	dH German Grade / 德国度
L (LOW) / 低	0	0	0mg/l	1200	CaCO <sub>3</sub> Calcium Carbonate / 碳酸钙

## Emptying the system before a period of non-use and for frost protection, or before a repair / 将长时间不使用 防结霜或维修前需清空机器

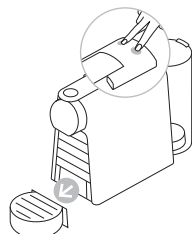

- ① **To enter the emptying mode**, press both the Espresso and Lungo buttons to turn the machine off.

**进入清空模式**，首先同时按下浓缩咖啡及大杯咖啡按钮来关闭机器电源。

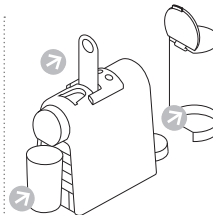

- ② **Remove the water tank and open the lever.** Place a container under the coffee outlet.

**移除水箱并抬起手柄**，在咖啡出口下方放置一个容器。

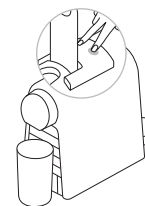

- ③ **Press both the Espresso and Lungo buttons for 5 seconds.** Both LEDs blink alternatively.

**同时按下浓缩咖啡和大杯咖啡按钮5秒钟**。两个LED指示灯会交替闪烁。

- ④ **Emptying process begins.** Machine switches off automatically when procedure is finished.

**机器开始清空。**程序结束后，机器会自动关机。



- ⑤ **Close the lever.** Empty and clean the used capsule container, the drip tray and the drip base.

**关闭手柄。**清空并清洗粉囊盒，滴水盘和滴水盘底座。



## EN Troubleshooting / 故障排除

CN

<b>No light indicator.</b>	- <b>Check</b> the power outlet, plug, voltage, and fuse. In case of problems, <b>call</b> the <i>Nespresso</i> Club.
<b>No coffee, no water.</b>	- First use: <b>fill</b> water tank with warm water (max. 55° C) and <b>run through</b> machine according to instructions on page 9. - Water tank is empty. <b>Fill</b> water tank. - <b>Descale</b> if necessary; see Descaling section.
<b>Coffee comes out very slowly.</b>	- Flow speed depends on the coffee variety. - <b>Descale</b> if necessary; see Descaling section.
<b>Coffee is not hot enough.</b>	- <b>Preheat</b> cup. - <b>Descale</b> if necessary.
<b>Capsule area is leaking (water in capsule container).</b>	- <b>Position</b> capsule correctly. If leakages occur, <b>call</b> the <i>Nespresso</i> Club.
<b>Irregular blinking.</b>	- <b>Send</b> appliance to repair or <b>call</b> the <i>Nespresso</i> Club.
<b>No coffee, just water runs out (despite inserted capsule).</b>	- In case of problems, <b>call</b> the <i>Nespresso</i> Club.

<b>指示灯不亮。</b>	- <b>检查供电</b> ，插头，电压和保险丝。问题未解决，请致电奈斯派索用户俱乐部。
<b>没有咖啡或水流出。</b>	- 首次使用： <b>请按照</b> 使用说明书第9页的内容，在水箱中加入低于55°C的 <b>温水冲洗</b> 设备。 - 水箱已空。在水箱中注入饮用水。 - <b>必要时</b> 除垢，参见除垢部分。
<b>咖啡流出速度很慢。</b>	- 咖啡流速与咖啡种类有关。 - <b>必要时</b> 除垢，参见除垢部分。
<b>咖啡不够热。</b>	- <b>预热</b> 咖啡杯。 - <b>必要时</b> 除垢。
<b>粉囊区域漏水 (粉囊盒中有水)。</b>	- <b>正确</b> 放置粉囊。如果有泄漏，请致电奈斯派索用户俱乐部。
<b>不规则闪烁。</b>	- <b>将</b> 咖啡机送去修理或请致电奈斯派索用户俱乐部。
<b>不出咖啡，只有水流出 (已放入咖啡胶囊)。</b>	- 如果有任何问题，请致电奈斯派索用户俱乐部。

## Disposal and environmental protection / 废弃处理及环境保护

**This appliance complies** with the EU Directive 2012/19/EC. Packaging materials and appliance contain recyclable materials.

Your appliance contains valuable materials that can be recovered or can be recycled. Separation of the remaining waste materials into different types facilitates the recycling of valuable raw materials. Leave the appliance at a collection point. You can obtain information on disposal from your local authorities.

To know more about *Nespresso* sustainability strategy, go to [www.nespresso.com/positive](http://www.nespresso.com/positive).

本机器遵从欧盟的法规EU Directive 2012/19/EC。包装材料和机器本身均包含一些可回收材料。您的咖啡机包含一些有价值的材料，这些材料可以被回收再利用。分开存储剩余的废弃的材料和可回收的材料。把机器送到收集点。您可以通过本地的相关机构获得废物处理的信息。

请登录网站[www.nespresso.com/positive](http://www.nespresso.com/positive)了解更多*Nespresso*的可持续发展战略。

## Limited Guarantee / 有限保修

EN

CN

**Nespresso guarantees** this product against defects in materials and workmanship for a period of 2 years. The warranty period begins on the date of purchase and Nespresso requires presentation of the original proof of purchase to ascertain the date. During the warranty period, Nespresso will either repair or replace, at its discretion, any defective product at no charge to the owner. Replacement products or repaired parts will be warranted only for the unexpired portion of the original warranty or six months, whichever is greater. This limited warranty does not apply to any defect resulting from negligence, accident, misuse, or any other reason beyond Nespresso's reasonable control, including but not limited to: normal wear and tear, negligence or failure to follow the product instructions, improper or inadequate maintenance, calcium deposits or descaling, connection to improper power supply, unauthorized product modification or repair, use for commercial purposes, fire, lightning, flood or other external causes. This warranty is valid only in the country of purchase or in such other countries where Nespresso sells or services the same model with identical technical specifications. Warranty service outside the country of purchase is limited to the terms and conditions of the corresponding warranty in the country of service. Should the cost of repairs or replacement not be covered by this warranty, Nespresso will advise the owner and the cost shall be charged to the owner. This limited warranty shall be the full extent of Nespresso's liability however caused. Except to the extent allowed by applicable law, the terms of this limited warranty do not exclude, restrict or modify the mandatory statutory rights applicable to the sale of this product and are in addition to those rights. If you believe your product is defective, contact Nespresso for instructions on how to proceed with a repair. Please visit our website at [www.nespresso.com](http://www.nespresso.com) for contact details.

**自购买之日起两年内**，Nespresso 对本产品因材料不良及制造缺陷而导致的故障提供免费保修服务。本保修期自购买之日开始生效，Nespresso 要求您在要求保修时提供原始购买证明来确认本起始日期。在此期间，Nespresso 将视故障情况和类型对产品进行免费修理或退换。更换的产品或修理的部件将只享有原本保修期未完的部分或六个月，以时间较长者为准。此有限的保修服务不适用于任何由于疏忽、意外、错误使用或其他超出 Nespresso 合理控制范围内的故障，包括但不限于：正常的磨损所造成的故障，疏忽或未能根据产品说明书操作机器，不当或不足的维护，结垢和除垢，连接到错误的电源，非授权的产品修改或维修，用于商业用途，火灾，雷电，洪水或其他外部原因所导致的故障。本保修只在产品的购买国及销售和服务相同型号和规格产品的 Nespresso 市场有效。在购买国以外的保修将根据该提供服务国家的相应的保修条例执行。如果维修 Nespresso 成本不在本保修承诺的范围之内，Nespresso 会提示您支付相应的费用。本承诺由 Nespresso 全部责任。如果国家适用法律另有明确规定，本保修条例不排除/限制或修改法律规定的相关条例，并且是其补充。如果您认为您的产品有故障。请联系 Nespresso 来了解应送往何处进行维修。请登录我们的主页 [www.nespresso.com](http://www.nespresso.com) 来获取更多详细的联系方式。

## Contact the Nespresso Club / 联系奈斯派索会员俱乐部

**As we may not have foreseen all uses of your appliance**, should you need any additional information, in case of problems or simply to seek advice, call the Nespresso Club or your Nespresso authorized representative. Contact details for your nearest Nespresso Club or your Nespresso authorized representative can be found in the «Welcome to Nespresso» folder in your machine box or at [nespresso.com](http://nespresso.com)

如果您需要任何额外的信息，遇到任何问题或寻求建议，请拨打奈斯派索用户俱乐部电话或奈斯派索授权方。离您最近的奈斯派索俱乐部或授权方的联系方式可在您机器包装箱内的“欢迎加入奈斯派索”文件夹中或 [nespresso.com](http://nespresso.com) 中找到。



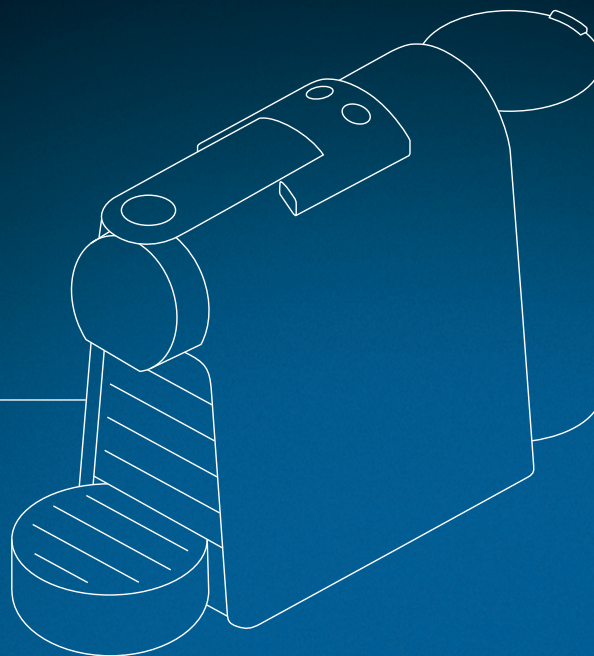

ESSENZA  
MINI  
MY MACHINE



**NESPRESSO**<sup>®</sup>